

NITTE MEENAKSHI INSTITUTE OF TECHNOLOGY

(A Unit of Nitte Education Trust(R),Mangalore)

(AN AUTONOMOUS INSTITUTION AFFILIATED TO VISVESVARAYA TECHNOLOGICAL UNIVERSITY,BELGAUM)

APPROVED BY UGC,ACCREDITED BY NATIONAL BOARD OF ACCREDITATION (AICTE), NEW DELHI & NAAC

With A+ Grade

Govindapura, Gollahalli, P.B. No 6429, Yelahanka, Bangalore 560-064, Karnataka, India

Format for Presentation of Best Practices Best Practice -1

1. Title of the Practice

Stimulating Culture of Multidisciplinary Research

2. Objectives of the Practice

- To inculcate culture of multidisciplinary research and innovation among UG/PG/Ph.D. Sstudents and Faculty
- To provide platform and opportunities for students and faculty from different discipline to collaborate and share research activities and ideas
- To establish Centre of Excellence in the multidisciplinary research areas by collaborating with advanced research institutes like IISc./ISRO/NAL/CAIR/ etc.

3. The Context

In the present context, In the Indian higher education system, different research/study disciplines are treated as opaque walls. This hinders quality research and innovation to be part of the higher education system. These walls need to be adequately porous so that any student pursuing in any discipline has to necessarily go beyond the frontiers of his/her own domain thus enabling them to pursue knowledge of yet another discipline. In such an environment, the horizon of research one pursues gets deeper and leads to newer and innovative practices.

However, Multidisciplinary research requiresadequate background of numerous specialized disciplines, which aim at achieving a common goal. It leads to improved opportunities and flexibility to the students to get better employment/research careers.

4. The Practice

In the context of Indian higher education, if the departments work independently then the solution developed may not be feasible to meet the societal/global needs. However, most of the current requirements need expertise of several disciplines. In this context, NMIT has

NITTE MEENAKSHI INSTITUTE OF TECHNOLOGY

(A Unit of Nitte Education Trust(R),Mangalore)

(AN AUTONOMOUS INSTITUTION AFFILIATED TO VISVESVARAYA TECHNOLOGICAL UNIVERSITY,BELGAUM)

APPROVED BY UGC,ACCREDITED BY NATIONAL BOARD OF ACCREDITATION (AICTE), NEW DELHI & NAAC

With A+ Grade

Govindapura, Gollahalli, P.B. No 6429, Yelahanka, Bangalore 560-064, Karnataka, India

encouraging the practice of Multidisciplinary Research. The faculty and students of different disciplines will come together to work towards a common goal.

Practice:

Established Multi-Disciplinary Research Centers, These centers provide advanced research facilities and training for faculty and students drawn from different disciplines, such as

- Center of Small Satellite Research in collaboration with ISRO, Bangalore.
- Center of Robotics Research.
- Centre of Nanomaterials and MEMS in collaboration with IISc, Bangalore.
- Center of Design and Process Simulation in collaboration with Dassault Systems
- Center of Computational Fluid Dynamics in collaboration with NAL.
- Center of Aerospace and IoT in collaboration with Dassault System & PTC. 11 Labs have been established with a funding of about Rs.25 Crores.
- Center for Cyber Security &IOT in collaboration with Subex Company.
- Introduced Courses related to Muti-Disciplinary Research. Institute offers wide range of courses as Open Electives thus encouraging the students to acquire knowledge in various emerging domains.
- Seed money for the young Faculty to pursue multidisciplinary research.
- MoUs with reputed R&D Organizations/Industries/Universities of India & Abroad.
- Department wise monthly Faculty Colloquium, to share the domain knowledge among the faculty of the department as well as other departments.
- Reduction in workload for the faculty working in Research Centers for better research productivity
- Financial assistance to publish research articles, filing patents and to attend FDPs/Workshops/Training programs

5. Evidence of Success

Provide evidence of success such as performance against targets and benchmarks of review results. What do these results indicate? Describe in about 200 words.

NITTE MEENAKSHI INSTITUTE OF TECHNOLOGY

(A Unit of Nitte Education Trust(R),Mangalore)

(AN AUTONOMOUS INSTITUTION AFFILIATED TO VISVESVARAYA TECHNOLOGICAL UNIVERSITY,BELGAUM)

APPROVED BY UGC,ACCREDITED BY NATIONAL BOARD OF ACCREDITATION (AICTE), NEW DELHI & NAAC

With A+ Grade

Govindapura, Gollahalli, P.B. No 6429, Yelahanka, Bangalore 560-064, Karnataka, India

- Good numbers of UG/PG/PhD students are involved in multidisciplinary Research activities.
- Faculty members who are working in the research centers are able to get good amount of Funding from National funding agencies such as DST, DIT, AICTE, DSIR, VGST, VTU etc.
- Good number of Research articles is published in SCI/WOS/Scopus Journals & Conferences.
- Three Indian Patents have been granted & 34 Patents have been published.
- During Last five years, about Rs. 1 crore has been given as seed money to the Faculty for encouraging research.
- NMIT has signed an MoU with North Dakota State University(NDSU), Fargo,USA which is a renowned Land Grant Research University for immersion programs Faculty exchange & promotion of joint Research.
- Robotics Engineering-Lego Mindstorms and TETRIX Course is offered as an open elective for students across all engineering departments for Sem 3 and 4 from the academic year 2015-16. The Course has 40% theory & 60% Practical sessions.
- Electronics/Mechanical /Electrical/Computer science faculty and students are involved in Small Satellite Research Program.
 - First time in India, under this Center, the UG students had successfully built India's first Pico Satellite "STUDSAT-I" which was launched onto space through ISRO's PSLV-C15 vehicle on 12th July 2010 from Sriharikota.
 - STUDSAT team has created a National Record by entering into LIMCA BOOK of RECORDS 2011 Edition
- NMIT has setup an unique Ground Station to track the Satellites (NASTRAC) which has already obtained an Indian Patent.
- The multidisciplinary group in NMIT developed several vision based robots for various applications. Students have developed a Pick &Place Robot and OFC link which has been kept as permanent exhibit at Birla Science Centre, Hyderabad
- Graduates who worked in these multidisciplinary research centres having admitted by the World's premier Universities like Surrey/Texas/Oxford/Indiana/etc. for their Masters/PhD programs.

NITTE MEENAKSHI INSTITUTE OF TECHNOLOGY

(A Unit of Nitte Education Trust(R),Mangalore)

(AN AUTONOMOUS INSTITUTION AFFILIATED TO VISVESVARAYA TECHNOLOGICAL UNIVERSITY,BELGAUM)

APPROVED BY UGC,ACCREDITED BY NATIONAL BOARD OF ACCREDITATION (AICTE), NEW DELHI & NAAC

With A+ Grade

Govindapura, Gollahalli, P.B. No 6429, Yelahanka, Bangalore 560-064, Karnataka, India

- Graduates who worked in these multidisciplinary research centres have got better placement offers with high CTC from Core Industries/R & D Organizations.

6. Problems Encountered and Resources Required

It is difficult to coordinate students drawn from different disciplines to undertake interdisciplinary research. Since UG students actively participating in R&D work leave the college after their graduation, continuing the projects undertaken requires financial support to retain them after their graduation. This requires some additional financial resources and availability of senior faculty. Availability of time for UG students to work in these multidisciplinary Centres is less because of tight academic schedule.

7. Notes (Optional)

NITTE MEENAKSHI INSTITUTE OF TECHNOLOGY

(A Unit of Nitte Education Trust(R),Mangalore)

(AN AUTONOMOUS INSTITUTION AFFILIATED TO VISVESVARAYA TECHNOLOGICAL UNIVERSITY,BELGAUM)

APPROVED BY UGC,ACCREDITED BY NATIONAL BOARD OF ACCREDITATION (AICTE), NEW DELHI & NAAC

With A+ Grade

Govindapura, Gollahalli, P.B. No 6429, Yelahanka, Bangalore 560-064, Karnataka, India

Best Practice -2

1. Title of the Practice

Learner Centric Teaching & Assessment

2. Objectives of the Practice

- To seed in a clear expectation of what needs to be accomplished by the student at the end of the course/program.
- To structure Learning & Teaching process catering to the students needs.
- To increase student involvement which allows them to feel responsible for their own learning,
- To uphold the standards of engineering education and to ensure that students will be prepared for professional life after they graduate.
- To decide what learning level the student would be at

3. The Context

Grade based educational system irrelevant and does not rely on the conventional teaching methods. Outcome based education (OBE) is the latest paradigm shift in the Indian Higher education system. The increasing need to produce more able and competitive learners for the globalized world has led to a reform in the education system.

OBE is a education reform model which is based on a student centric learning and focuses on the outcomes instead of the input. In contrast with traditional education, OBE puts much emphasis on the learning process being effectively pursued and managed by the students themselves and the Faculty are only acting as facilitators.

Specific and clearly defined outcomes must be established so that the students will be able to set their own expectations and means to achieve the desired outcomes. With OBE, the assessments methods of various skills, knowledge and attitudes become diverse and various learning pedagogies needs to be introduced to ensure the achievement of the outcomes. The defined outcomes must be specific, measurable, achievable, realistic and time-based.

The main problem with the implementation of outcome based education is the broad definition of outcome based education itself. The attainment of soft skills/lifelong learning skills are difficult to measure, the assessment of soft skills must be conducted in several courses. While

NITTE MEENAKSHI INSTITUTE OF TECHNOLOGY

(A Unit of Nitte Education Trust(R),Mangalore)

(AN AUTONOMOUS INSTITUTION AFFILIATED TO VISVESVARAYA TECHNOLOGICAL UNIVERSITY,BELGAUM)

APPROVED BY UGC,ACCREDITED BY NATIONAL BOARD OF ACCREDITATION (AICTE), NEW DELHI & NAAC

With A+ Grade

Govindapura, Gollahalli, P.B. No 6429, Yelahanka, Bangalore 560-064, Karnataka, India

OBE emphasizes on student centric learning, the actual implementation of OBE is still strongly dependent on Faculty as presenters of knowledge. The implementation of OBE in engineering education also requires the integration of laboratory works which differentiates the engineering programme from many other disciplines.

4. The Practice

NMIT has successfully introduced Outcome Based Education since 2012. Institute is regularly conducting Awareness Training on OBE/ Pedagogy Training on Outcome Based Learning and Teaching (OBLT) to the Faculty. During orientation program, student will be made aware of OBE. The Institute has effective administrative setup in the form of various committees such as DUGC, PAC, DAB, BOE, BOS, and IQAC & AC to implement/monitor the Out Come Based Curricula/Teaching/Assessment.

Towards the framing of Outcome Based Curricula , DUGC/BOS will refer knowledge areas proposed by Professional Body Guidelines (IEEE/ACM/ASCE/ASME/etc), guidelines of UGC/AICTE/VTU and syllabi of premier Institution. The Institute will take feedback/input from all the stakeholders viz. Students/Faculty/Alumni/Parents/Employers.

Towards the effective Outcome based Teaching/Learning, Departments will conduct Faculty Brainstorming sessions during the beginning of the semester to deliberate on Delivery & Assessment Methods. Faculty has adopted course specific effective/innovative delivery methods such as

- Demonstration Based Teaching
- App Based Teaching
- Certification Based Learning
- MOOC Based Learning through SVAYAM/NPTE/UDEMY
- Google Class Rooms
- Tool based teaching
- Lectures interspersed with discussions
- Tutorials
- Course Projects/ Mini Project

NITTE MEENAKSHI INSTITUTE OF TECHNOLOGY

(A Unit of Nitte Education Trust(R),Mangalore)

(AN AUTONOMOUS INSTITUTION AFFILIATED TO VISVESVARAYA TECHNOLOGICAL UNIVERSITY,BELGAUM)

APPROVED BY UGC,ACCREDITED BY NATIONAL BOARD OF ACCREDITATION (AICTE), NEW DELHI & NAAC

With A+ Grade

Govindapura, Gollahalli, P.B. No 6429, Yelahanka, Bangalore 560-064, Karnataka, India

- Main Project
- Case Studies
- Industrial/Site Visits
- Programming Assignments
- Seminars
- Debates
- Written Assignments
- Hands on Sessions
- Self study /Internship
- Workshops/Invited Talks/Webinars

NMIT has adopted effective direct & indirect assessment methods to measure the learning outcomes. Faculty have designed effective rubrics for evaluating different Learning activities and Laboratory Experiments which result in accurate assessment of learning outcomes

The Institute/Departments have adopted the following practices

- MOOC Based Electives
- MOOC Based References for most of the courses
- Practical experiments are directly related to Real World Applications
- Long term Internship
- Plagiarism check for UG/PG/PhD Project Reports
- Latex Based Reports
- Practical Integrated Courses
- Industry Driven Electives
- Partial delivery of Course by Industry Experts

5. Evidence of Success

- Continuous Quality Improvement is in force where departments follows OBC => OBLT => OBA => Gap Analysis.
- Innovative delivery methods are adopted by the faculty which are students centric.

NITTE MEENAKSHI INSTITUTE OF TECHNOLOGY

(A Unit of Nitte Education Trust(R),Mangalore)

(AN AUTONOMOUS INSTITUTION AFFILIATED TO VISVESVARAYA TECHNOLOGICAL UNIVERSITY,BELGAUM)

APPROVED BY UGC,ACCREDITED BY NATIONAL BOARD OF ACCREDITATION (AICTE), NEW DELHI & NAAC

With A+ Grade

Govindapura, Gollahalli, P.B. No 6429, Yelahanka, Bangalore 560-064, Karnataka, India

- UG Programs are accredited by NBA under Tier-1 Scheme.
- Rubrics enables students to know the standard in teaching and learning expected for successful completion of the course/ project.
- Improved practical skills of the students in all aspects of teaching and learning.
- Improved innovative culture among the students, that resulted in many National Level awards
- Learning activities are making the Students Industry Ready resulting in higher & better employment
- Fast learners are taking up Higher studies in reputed Universities by appearing in GATE/GRE/IELTS/TOEFL etc.

6. Problems Encountered and Resources Required

Across different programs or even different instructors, outcomes could be interpreted differently, leading to a difference in education, even though the same outcomes were said to be achieved. By outlining specific outcomes, a holistic approach to learning is lost. Learning finds itself being reduced to something that is specific, measurable, and observable. As a result, outcomes are not yet widely recognized as a valid way of conceptualizing what learning is about. Further Faculty & students are overloaded with academic activities.

7. Notes (Optional)

NMIT offers courses like NCC, Values Based Leadership, Constitution of India and Professional Ethics (CIP), Environmental Studies leading to overall development of the students

Any other information regarding Institutional Values and Best Practices which the Autonomous College would like to include.

NITTE MEENAKSHI INSTITUTE OF TECHNOLOGY

(A Unit of Nitte Education Trust(R),Mangalore)

(AN AUTONOMOUS INSTITUTION AFFILIATED TO VISVESVARAYA TECHNOLOGICAL UNIVERSITY,BELGAUM)

APPROVED BY UGC,ACCREDITED BY NATIONAL BOARD OF ACCREDITATION (AICTE), NEW DELHI & NAAC

With A+ Grade

Govindapura, Gollahalli, P.B. No 6429, Yelahanka, Bangalore 560-064, Karnataka, India

Center for Nanomaterials and MEMS

About the Center

This centre focuses on research areas of Nano material synthesis, Thin film deposition and MEMS device solution.

Research in nano materials and MEMS has recently gained momentum with many academicians, researchers and industries taking active part in it. The Center has been carrying out collaborative work with all National MEMS Design Centers across the country with the help of Professors at CeNSE and ECE and Instrumentation Departments of IISc. The area is a multidisciplinary field; hence when students and faculty take active part in this research, they get a complete view of different facets of Science and Technology and their applications. This helps in building a connection between the institute and industry.

Objectives of the Center

- Develop smart materials for MEMS sensors and actuators, Energy storage and RO systems applications.
- To serve as an educational and training centre in the frontier areas of science and technology of smart materials for students, scientists and engineers.
- To give knowledge & create awareness in new technologies and to work on challenging areas for societal benefits and for nation development.
- To train manpower and enhancing their domain knowledge on smart materials for development of thrust areas of research.
- To offer technical advice and support to researchers in academic institutions / universities and industries in the area of smart materials and systems
- To play a lead role in University system by establishing a Tier 2 center of Excellence in Micro and Nano technologies and develop links with Tier 1 centers in IITs and IISc as well as Industries.

NITTE MEENAKSHI INSTITUTE OF TECHNOLOGY

(A Unit of Nitte Education Trust(R),Mangalore)





(AN AUTONOMOUS INSTITUTION AFFILIATED TO VISVESVARAYA TECHNOLOGICAL UNIVERSITY,BELGAUM)

APPROVED BY UGC,ACCREDITED BY NATIONAL BOARD OF ACCREDITATION (AICTE), NEW DELHI & NAAC

With A+ Grade

Govindapura, Gollahalli, P.B. No 6429, Yelahanka, Bangalore 560-064, Karnataka, India

Major Equipment in the Center

Sl.no	Equipment Description	Image
1	Spin Coater	
2	RF / DC Sputtering System	
3	E-Beam Evaporation System	
4	Thermal Evaporation System	
5	Electrochemical Analyser	

NITTE MEENAKSHI INSTITUTE OF TECHNOLOGY



(A Unit of Nitte Education Trust(R),Mangalore)

(AN AUTONOMOUS INSTITUTION AFFILIATED TO VISVESVARAYA TECHNOLOGICAL UNIVERSITY,BELGAUM)

APPROVED BY UGC,ACCREDITED BY NATIONAL BOARD OF ACCREDITATION (AICTE), NEW DELHI & NAAC

With A+ Grade

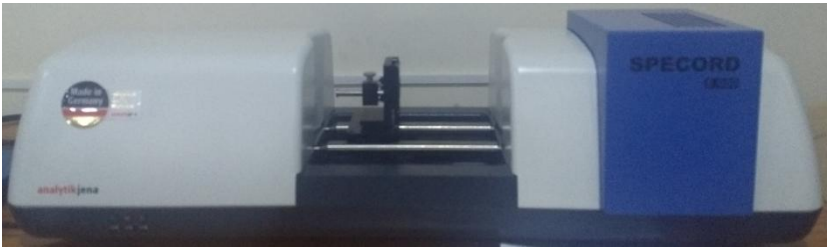
Govindapura, Gollahalli, P.B. No 6429, Yelahanka, Bangalore 560-064, Karnataka, India

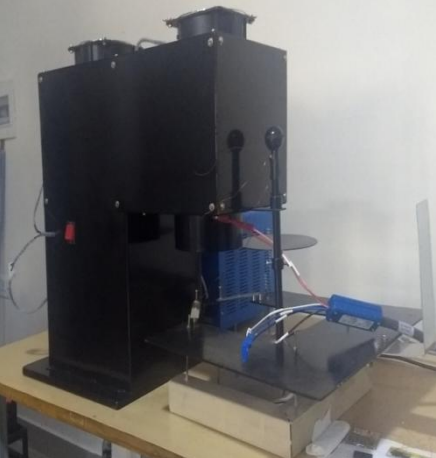
6	UV Visible Spectroscopy	
7	Corona Poling Unit	
8	Solar Simulator	

NITTE MEENAKSHI INSTITUTE OF TECHNOLOGY





(A Unit of Nitte Education Trust(R),Mangalore)

(AN AUTONOMOUS INSTITUTION AFFILIATED TO VISVESVARAYA TECHNOLOGICAL UNIVERSITY,BELGAUM)

APPROVED BY UGC,ACCREDITED BY NATIONAL BOARD OF ACCREDITATION (AICTE), NEW DELHI & NAAC

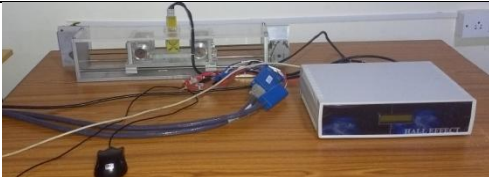
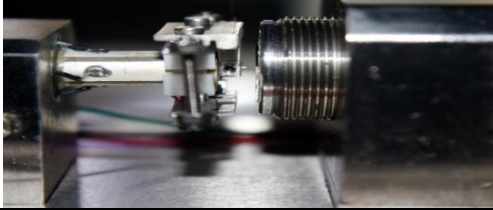
With A+ Grade

Govindapura, Gollahalli, P.B. No 6429, Yelahanka, Bangalore 560-064, Karnataka, India

9	Hall Effect	 A photograph showing a Hall effect experiment setup. It includes a power supply unit, a Hall effect probe, and various connecting wires on a wooden table.
10	Scanning Tunneling Microscope	 A photograph of a Scanning Tunneling Microscope (STM) setup, showing the probe tip and the scanning mechanism.
11	Tubular Chemical Vapor Deposition System	 A photograph of a tubular chemical vapor deposition (CVD) system, showing a glowing orange tube inside a metal chamber.
12	Magnetic Stirrer	 A photograph of two magnetic stirrer units. One has a digital display showing '0120'. A sign below the units reads 'MAGNETIC STIRRER'.
13	Hot air Oven	 A photograph of a hot air oven, showing the interior shelves and the control panel.
14	Muffle Furnace	 A photograph of a muffle furnace, showing the furnace chamber and a control unit on a table.

NITTE MEENAKSHI INSTITUTE OF TECHNOLOGY

(A Unit of Nitte Education Trust(R),Mangalore)

(AN AUTONOMOUS INSTITUTION AFFILIATED TO VISVESVARAYA TECHNOLOGICAL UNIVERSITY,BELGAUM)

APPROVED BY UGC,ACCREDITED BY NATIONAL BOARD OF ACCREDITATION (AICTE), NEW DELHI & NAAC

With A+ Grade

Govindapura, Gollahalli, P.B. No 6429, Yelahanka, Bangalore 560-064, Karnataka, India

Human Resources

In the Centre for Nanomaterials and MEMS (CNM) at NMIT, we have dynamic multidisciplinary group of researchers oriented and working for the objectives, in the following research areas:

- **Design, Simulation and Development of Micro-Electro-Mechanical systems (MEMS)**
- **Thin Film Materials Science and Engineering**
- **Nanomaterials Synthesis**

Collaborations

Foreign Collaborations

Moncton University, Canada- **Prof. Pandurang A.**

University of Michigan, USA – **Prof. Yogesh Gianchandhani**

Krasnoyarsk Scientific Center of the Siberian Branch of the Russian Academy of Sciences, Krasnoyarsk, Russia – **Dr. Volkov Nikita Valentinovich**

IISc, Bangalore

Prof. RudraPratap – MEMS, SiC thin films

Prof. G. Mohan Rao –Microelectronics

Prof. Rachit Agarwal– Bioengineering

Prof. M.M. Nayak – MEMS sensor packaging

PSG Tech, Coimbatore- CIGS Solar Cells

DBalitsolutions Pvt. Ltd- Development of Artificial Pancreas

Veterinary College Hassan- Development of cattle health monitoring system

NITTE MEENAKSHI INSTITUTE OF TECHNOLOGY

(A Unit of Nitte Education Trust(R),Mangalore)

(AN AUTONOMOUS INSTITUTION AFFILIATED TO VISVESVARAYA TECHNOLOGICAL UNIVERSITY,BELGAUM)

APPROVED BY UGC,ACCREDITED BY NATIONAL BOARD OF ACCREDITATION (AICTE), NEW DELHI & NAAC

With A+ Grade

Govindapura, Gollahalli, P.B. No 6429, Yelahanka, Bangalore 560-064, Karnataka, India

Centre for Design Engineering and Process Simulation

Centre for Design Engineering and Process Simulation (CDEPS) is a collaborative platform for Design Innovation and Design Solutions in association with industry and professionals. The Centre utilizes software for conceptual design, preliminary design, product development, process simulation, design optimization for product and process through simulation and manufacturing tools.



Thrust Areas of Research

- 3D Solid Modeling- Part Modeling, Assembly & Surface Design
- Design of Aerospace & Automotive products
- Composite Engineering
- Engineering Optimization
- Tool Design
- Ergonomics for Vehicle Design
- Structural & Thermal Analysis

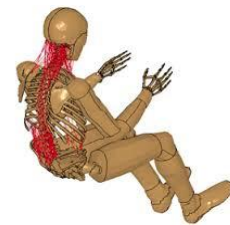
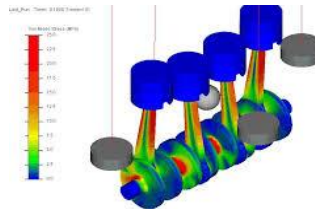

The Centre can provide its expertise in the area of Design & Systems Engineering to model and simulate the dynamic behavior of complex systems consisting of multi-disciplinary sub-systems, to perform multi-body dynamic modeling & simulation based using empirical relationships in parallel to FEA solutions.

The Centre for Design Engineering and Process Simulation is mainly working on innovative and creative development of design components from conceptual phase till product development through process simulation and optimization in diverse areas of specialization.

Objective



To create an environment among Students, Design Professionals & Faculty to access the world-class resources to cater to the need for effective Design, Analysis & Manufacturing methodology in support of efficient product development.

Activities at CDEPS:

- The Centre has upgraded the available software version CATIA V6 to 3D Experience from DassaultSystemes.
- The Centre has signed an MoU with Starya Mobility Pvt Ltd for the design and development of electric two-wheelers.



NITTE MEENAKSHI INSTITUTE OF TECHNOLOGY

(A Unit of Nitte Education Trust(R),Mangalore)

(AN AUTONOMOUS INSTITUTION AFFILIATED TO VISVESVARAYA TECHNOLOGICAL UNIVERSITY,BELGAUM)

APPROVED BY UGC,ACCREDITED BY NATIONAL BOARD OF ACCREDITATION (AICTE), NEW DELHI & NAAC

With A+ Grade

Govindapura, Gollahalli, P.B. No 6429, Yelahanka, Bangalore 560-064, Karnataka, India

- The Centre has signed anMoU with Bird Electronics Pvt Ltd. We are working on projects related to design and development of sensors to monitor air quality and projects related to “*mobility without pollution for global audience*”
- The Centre is working in coordination with IVARI Motors-one of the leading manufacturers of spring charging motors, for the Indigenizing/Local Substitution of Imported Spring Charging Motors used in Switchgears.
- The Centre is providing training on Product design and development for mechanical and aeronautical engineering students using software package obtained from Dassault Systems.

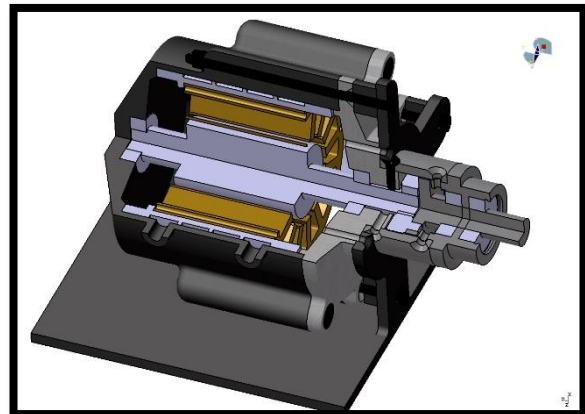
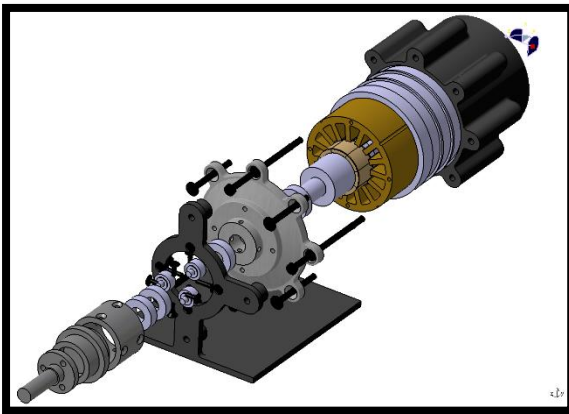

Project from Sarya Mobility Pvt Ltd - Design and Development of water cooled electric motor for two-wheeler mobility

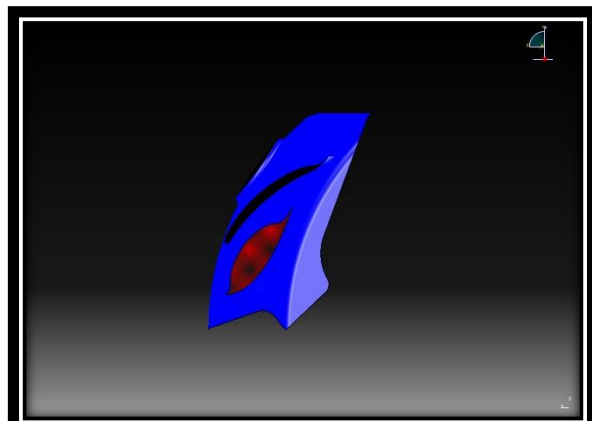
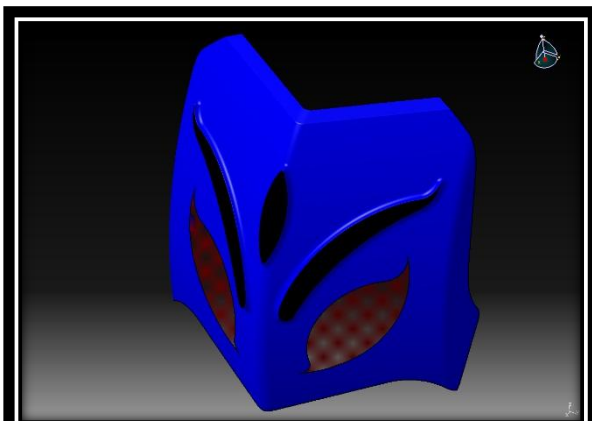

Project from Sarya Mobility Pvt Ltd - Design of electric two-wheeler body

NITTE MEENAKSHI INSTITUTE OF TECHNOLOGY

(A Unit of Nitte Education Trust(R),Mangalore)

(AN AUTONOMOUS INSTITUTION AFFILIATED TO VISVESVARAYA TECHNOLOGICAL UNIVERSITY,BELGAUM)

APPROVED BY UGC,ACCREDITED BY NATIONAL BOARD OF ACCREDITATION (AICTE), NEW DELHI & NAAC

With A+ Grade

Govindapura, Gollahalli, P.B. No 6429, Yelahanka, Bangalore 560-064, Karnataka, India

Workshops/Expert Lectures organized by CDEPS:



Skill Development Program on “Essentials of CATIA V5” for UG students during 09-13th July, 2018



Experts from Glisten Project Solutions Pvt Ltd delivering a talk about “Learning FEA through Applications” on 27/07/18



MrAnand Bhatia, Managing Director, Bird Electronics interacting with UG students about internships and research projects on 11/09/18



Experts from EDS Technologies delivering a talk about “E-learning solutions” on 25/10/18



MrHemantGadgil, Director: Industry Solutions Group from DassaultSystemes interacting with the faculty members about introducing industry offered electives for UG students. After successful interaction, a course – “C++ Programming for Scientific Application Development” has been introduced as a core elective for 4th semester UG students.

NITTE MEENAKSHI INSTITUTE OF TECHNOLOGY

(A Unit of Nitte Education Trust(R),Mangalore)

(AN AUTONOMOUS INSTITUTION AFFILIATED TO VISVESVARAYA TECHNOLOGICAL UNIVERSITY,BELGAUM)

APPROVED BY UGC,ACCREDITED BY NATIONAL BOARD OF ACCREDITATION (AICTE), NEW DELHI & NAAC

With A+ Grade

Govindapura, Gollahalli, P.B. No 6429, Yelahanka, Bangalore 560-064, Karnataka, India

Center for Robotics Research



Figure 1: M Tech CSE Lab



Figure 2: Robotics Lab



Figure 3: Image and Video Processing Lab



Figure 4: R & D Centre (CSE)



Figure 5: Vision Group of Science and Technology Lab



Figure 6: Robotics Engineering – LEGO MINDSTORM& TETRIX

Fig. 1 to 6 shows the view of the laboratories in the Post Graduate Computer Science Department

NITTE MEENAKSHI INSTITUTE OF TECHNOLOGY

(A Unit of Nitte Education Trust(R),Mangalore)

(AN AUTONOMOUS INSTITUTION AFFILIATED TO VISVESVARAYA TECHNOLOGICAL UNIVERSITY,BELGAUM)

APPROVED BY UGC,ACCREDITED BY NATIONAL BOARD OF ACCREDITATION (AICTE), NEW DELHI & NAAC

With A+ Grade

Govindapura, Gollahalli, P.B. No 6429, Yelahanka, Bangalore 560-064, Karnataka, India

CENTRE OF EXCELLENCE FOR SMALL SATELLITE RESEARCH

Satellite (STUDSAT - 1) Program at NMIT started in the year 2008 with a consortium of seven engineering colleges from Karnataka and Andhra Pradesh with NMIT as the lead college under the able leadership of Dr.JharnaMajumdar, Dean R&D, Prof. and Head Department of CSE(PG).

Under STUDSAT – 1 project, India’s first Pico – Satellite (weighing 850 gms) was designed, developed and integrated by the students, and was put into orbit on July 2010 from Shriharikota aboard the PSLVC – 15 along with CARTOSAT 2B. The satellite was placed in the orbit of 630km above the earth and had been successfully tracked by the Ground Station NASTRAC at NMIT.

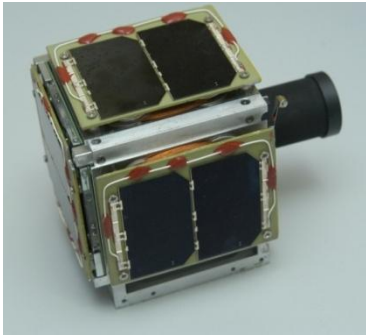

SatelliteFlight Model



Launching of Satellite

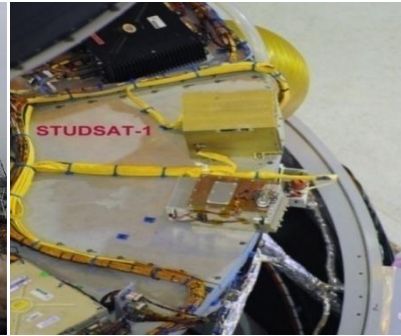

PSLV Equipment Bay



Collaboration with ISRO Team STUDSAT has been greatly appreciated and received by the participating colleges and Indian Space Research Organization (ISRO). ISRO has recognized NMIT as a Research Centre. A Memorandum of Understanding (MoU) was signed between the participating colleges and NitteMeenakshi Institute of Technology. This gave us the Impetus to develop 2nd Satellite (Project STUDSAT-2) to demonstrate Inter Satellite Communication in space

NITTE MEENAKSHI INSTITUTE OF TECHNOLOGY

(A Unit of Nitte Education Trust(R),Mangalore)

(AN AUTONOMOUS INSTITUTION AFFILIATED TO VISVESVARAYA TECHNOLOGICAL UNIVERSITY,BELGAUM)

APPROVED BY UGC,ACCREDITED BY NATIONAL BOARD OF ACCREDITATION (AICTE), NEW DELHI & NAAC

With A+ Grade

Govindapura, Gollahalli, P.B. No 6429, Yelahanka, Bangalore 560-064, Karnataka, India

STUDSAT-2

Continuing the legacy of Project STUDSAT -1, Project STUDSAT -2 was conceived. A new consortium was formed comprising following institutes,

1. NitteMeenakshi Institute of Technology, Bangalore - **Lead College**
2. M S Ramaiah Institute of Technology, Bangalore
3. R N S Institute of Technology, Bangalore
4. Nagarjuna College of Engineering and Technology, Bangalore
5. N M A M Institute of Technology, Nitte
6. Siddaganga Institute of Technology, Tumkur
7. Sri Siddhartha Institute of Technology, Tumkur



STUDSAT 2 is set to create another milestone, as it is “India’s First Twin Satellite Mission”. This project aims to explore and prove Inter-Satellite Communication and several cutting edge technologies. The STUDSAT-1 mission enriched the STUDSAT-2 team with knowledge and expertise required to take up such a mammoth endeavor. Learning from the STUDSAT-1 team helped the new team to identify the mission objectives for STUDSAT-2. These were the first ever proposed by any Student Satellite missions.

The Objectives are:

1. In-Orbit Satellite Separation: The twin-satellites (STUDSAT-2A/2B) will be launched in composite form and separated in-orbit
2. Inter-Satellite Communication: The Twins after being separated should communicate in space, in UHF band
3. Automatic Identification System (AIS): To receive signals from ships (class >300tons) to locate and map ship's position and movement.
4. Beacon Data Relay: Messages from HAM community can be relayed via Beacon.
5. De-orbiting: STUDSAT-2B will be de-orbited using a Drag Sail, the first planned on an Indian satellite.

NITTE MEENAKSHI INSTITUTE OF TECHNOLOGY

(A Unit of Nitte Education Trust(R),Mangalore)

(AN AUTONOMOUS INSTITUTION AFFILIATED TO VISVESVARAYA TECHNOLOGICAL UNIVERSITY,BELGAUM)

APPROVED BY UGC,ACCREDITED BY NATIONAL BOARD OF ACCREDITATION (AICTE), NEW DELHI & NAAC

With A+ Grade

Govindapura, Gollahalli, P.B. No 6429, Yelahanka, Bangalore 560-064, Karnataka, India

As evident from the STUDSAT-2 mission objective the mission design requires complex satellite bus Design. The team could come up with indigenously developed modules, to name a few.

1. Tetrahedral Reaction Wheel Actuation System.
2. Magnetic Torquer Coils for De-tumbling of the Satellite.
3. Satellite Separation Mechanism.
4. On Board Processor Redundancy.

STUDSAT-2 Funding

Name of the Project	Sponsoring agency	Amount Sanctioned	Name of the Principal Investigator	Year of Sanction	Duration	Status
Student Satellite Project (STUDSAT-2)	Contribution of Seven Engineering Colleges (Consortium of Karnataka under VTU)	Rs. 70 Lakhs	Principal and Consortium of Seven Engg. Colleges of Karnataka	2011	3 years	Ongoing
Student Satellite Project (STUDSAT-2)	VTU	Rs.45 Lakhs	Principal and Consortium of Seven Engg. Colleges of Karnataka	2011	4 years	Ongoing

Resource Persons

Dr. S Sandya, Project Director STUDSAT-2

Prof Emeritus G V C RAJAN Project STUDSAT-2

Kannan T, Research Associate, Project STUDSAT-2

Mr.Somnath Singh, Research Associate, Project STUDSAT-2

Ms.Pooja K P, Research Associate, Project STUDSAT-2

Important Events

Team STUDSAT at SDSC, SHAR Sriharikota ISRO for national workshop on challenges and modern technique 5th March 2018



NITTE MEENAKSHI INSTITUTE OF TECHNOLOGY

(A Unit of Nitte Education Trust(R),Mangalore)

(AN AUTONOMOUS INSTITUTION AFFILIATED TO VISVESVARAYA TECHNOLOGICAL UNIVERSITY,BELGAUM)
APPROVED BY UGC,ACCREDITED BY NATIONAL BOARD OF ACCREDITATION (AICTE), NEW DELHI & NAAC
With A+ Grade

Govindapura, Gollahalli, P.B. No 6429, Yelahanka, Bangalore 560-064, Karnataka, India

Prototype Demonstration of Twin Nanosatellite 7th Apr 2018 at CSSR Lab to NMIT College Management, Faculty and College Coordinators of Consortium of Colleges



Team STUDSAT at Bangalore Space EXPO 3rd to 5th September 2018



NITTE MEENAKSHI INSTITUTE OF TECHNOLOGY

(A Unit of Nitte Education Trust(R),Mangalore)

(AN AUTONOMOUS INSTITUTION AFFILIATED TO VISVESVARAYA TECHNOLOGICAL UNIVERSITY,BELGAUM)
APPROVED BY UGC,ACCREDITED BY NATIONAL BOARD OF ACCREDITATION (AICTE), NEW DELHI & NAAC

With A+ Grade

Govindapura, Gollahalli, P.B. No 6429, Yelahanka, Bangalore 560-064, Karnataka, India



PCB EPS:

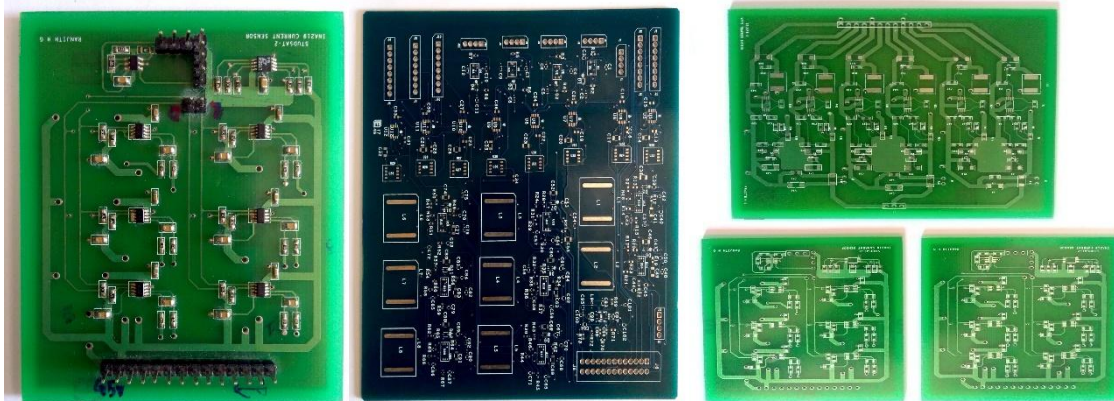

New PCBs have been designed to test the entire prototype module.

NITTE MEENAKSHI INSTITUTE OF TECHNOLOGY

(A Unit of Nitte Education Trust(R),Mangalore)

(AN AUTONOMOUS INSTITUTION AFFILIATED TO VISVESVARAYA TECHNOLOGICAL UNIVERSITY,BELGAUM)

APPROVED BY UGC,ACCREDITED BY NATIONAL BOARD OF ACCREDITATION (AICTE), NEW DELHI & NAAC

With A+ Grade

Govindapura, Gollahalli, P.B. No 6429, Yelahanka, Bangalore 560-064, Karnataka, India



NitteMeenakshi Institute of Technology (NMIT), has conceptualized an idea (First of its kind) of establishing Center of Excellence(CoE) for skill development on **Aerospace** and **Internet of Things IoT** in collaboration with renowned companies with an objective ‘to impart high end modern technical skills and knowledge in engineering graduates and make them **Industry Ready**.



The objective of the CoE Program Centers around “To serve the society as a Centre for quality technical education will provides long-term societal benefits through transmitting advanced knowledge, discovering new knowledge and function as a contributor of creativity and innovation”

Training

- A structured training for 500 hrs in each domain distributed for 5 semesters of B.E course is being conceptualized including application oriented and Industry based case studies and projects.
- This training will enhance the skill set of graduates with a high end competency according to industry standards. Importantly, the teaching content and methodology is designed by the Industry experts and collaborations with many reputed companies in the respective areas are being planned for real time exposure and Placement of students
- Program 1: CoE for Aerospace
- Program 2: CoE for IoT

NITTE MEENAKSHI INSTITUTE OF TECHNOLOGY

(A Unit of Nitte Education Trust(R),Mangalore)

(AN AUTONOMOUS INSTITUTION AFFILIATED TO VISVESVARAYA TECHNOLOGICAL UNIVERSITY,BELGAUM)

APPROVED BY UGC,ACCREDITED BY NATIONAL BOARD OF ACCREDITATION (AICTE), NEW DELHI & NAAC

With A+ Grade

Govindapura, Gollahalli, P.B. No 6429, Yelahanka, Bangalore 560-064, Karnataka, India

Inauguration:

It was inaugurated on August 13 2018 in New Auditorium at NMIT campus .

Chief Guest	Guest of Honour	Guest of Honour	Special Invitee	Presided by
				
Dr. Harsh Vardhan Hon'ble Union Minister for Science & Technology & Earth Sciences, Government of India	Shri D. V. Sadananda Gowda Hon'ble Union Minister for Statistics & Programme Implementation, Government of India	Prof. N. R. Shetty Chancellor, Central University of Kamataka, Kalaburagi, Former Vice Chancellor of Bangalore University & Advisor Nitte Education Trust	Shri S. R. Vishwanath MLA Yelahanka Constituency Bengaluru	Shri N. Vinaya Hegde Hon'ble Chancellor, NITTE (Deemed to be University) President - Nitte Education Trust



Highlights:

AEROSPACE DOMAIN

Product Design & Development
Flight Physics Lab
Aerospace Structure Design Lab
Aircraft system Lab
Composites Lab

IOT DOMAIN

Machine Learning and Artificial
Intelligence
IOT Lab
Smart Power Generation
Smart Public transport
Smart Manufacturing
Smart City
Reality Lab

NITTE MEENAKSHI INSTITUTE OF TECHNOLOGY

(A Unit of Nitte Education Trust(R),Mangalore)

(AN AUTONOMOUS INSTITUTION AFFILIATED TO VISVESVARAYA TECHNOLOGICAL UNIVERSITY,BELGAUM)

APPROVED BY UGC,ACCREDITED BY NATIONAL BOARD OF ACCREDITATION (AICTE), NEW DELHI & NAAC

With A+ Grade

Govindapura, Gollahalli, P.B. No 6429, Yelahanka, Bangalore 560-064, Karnataka, India

BENEFITS TO STUDENTS

- . High end skills set as sought by Industry
- . Proficiency Certification
- . Exposure on real-time Projects
- . Industry ready and placement in core engineering companies

BENEFITS TO INDUSTRY

- No On-Job training required
- Lateral Hiring at the cost of fresher
- Reduce operation cost & focus on core business
- Reduce cost of hiring
- Large skill pools at single location
- **Prospective Recruiters:**
- Boieng, Siemens, Airbus, Tata Aerospace and Defense Limited, Dassault Reliance Aerospace Limited, PTC, IBM, HP, Fugen



Class room

NITTE MEENAKSHI INSTITUTE OF TECHNOLOGY

(A Unit of Nitte Education Trust(R),Mangalore)

(AN AUTONOMOUS INSTITUTION AFFILIATED TO VISVESVARAYA TECHNOLOGICAL UNIVERSITY,BELGAUM)

APPROVED BY UGC,ACCREDITED BY NATIONAL BOARD OF ACCREDITATION (AICTE), NEW DELHI & NAAC

With A+ Grade

Govindapura, Gollahalli, P.B. No 6429, Yelahanka, Bangalore 560-064, Karnataka, India



Aerospace Lab setup

COE Partners



A strategic collaboration has been made with Dassault systems, a European multinational software company which will be technology partner for Aerospace domain



PTC and IBM, American MNC companies as technology partners for IoT domain.



Dysmech Competency Services, Pune will be the Implementation partner in establishing the CoE and in setting up the State of the Art Infrastructure and curricula.

NITTE MEENAKSHI INSTITUTE OF TECHNOLOGY

(A Unit of Nitte Education Trust(R),Mangalore)

(AN AUTONOMOUS INSTITUTION AFFILIATED TO VISVESVARAYA TECHNOLOGICAL UNIVERSITY,BELGAUM)

APPROVED BY UGC,ACCREDITED BY NATIONAL BOARD OF ACCREDITATION (AICTE), NEW DELHI & NAAC

With A+ Grade

Govindapura, Gollahalli, P.B. No 6429, Yelahanka, Bangalore 560-064, Karnataka, India



MOU Signed between DCS, Dassult Systems and NMIT

COE Labs

NITTE MEENAKSHI INSTITUTE OF TECHNOLOGY

(A Unit of Nitte Education Trust(R),Mangalore)

(AN AUTONOMOUS INSTITUTION AFFILIATED TO VISVESVARAYA TECHNOLOGICAL UNIVERSITY,BELGAUM)

APPROVED BY UGC,ACCREDITED BY NATIONAL BOARD OF ACCREDITATION (AICTE), NEW DELHI & NAAC

With A+ Grade

Govindapura, Gollahalli, P.B. No 6429, Yelahanka, Bangalore 560-064, Karnataka, India

CoE Labs
Product Design and Development Lab
Flight Physic Validation Lab
Reality Lab
Aerospace Structures Design Lab
Aircraft Systems Lab
Composite Lab
Smart CoE
Smart Lab Internet of Things
Generator Monitoring System
Smart Public Transport
Smart Manufacturing
Smart City

Events conducted in 2019:

- 1) Workshop on 2020 technology was conducted from 7/1/19 to 12/1/19
- 2) Boot Camp was conducted on 28/1/19 to 2/2/19, expert members of DCS team conducted the camp.
- 3) I LEAD (Interdisciplinary Learn Educate Analyse and Do) Contest was announced based on the following themes:

Theme A: Study of Small Hypersonic Plane

Theme B: IoT Gateway for NMIT Smart Campus

And Prize money of 2 Lakhs with 1,50,000 for students and 50,000 for faculty advisors

NITTE MEENAKSHI INSTITUTE OF TECHNOLOGY

(A Unit of Nitte Education Trust(R),Mangalore)

(AN AUTONOMOUS INSTITUTION AFFILIATED TO VISVESVARAYA TECHNOLOGICAL UNIVERSITY,BELGAUM)

APPROVED BY UGC,ACCREDITED BY NATIONAL BOARD OF ACCREDITATION (AICTE), NEW DELHI & NAAC

With A+ Grade

Govindapura, Gollahalli, P.B. No 6429, Yelahanka, Bangalore 560-064, Karnataka, India

Teaching & Learning Process:

- Delivery methods are adopted to achieve the Learning Outcomes:
 - Demonstration Based Teaching
 - App Based Teaching
 - Certification Based Learning
 - Course Projects.
 - Case Studies.
 - Programming Assignments.
 - Hands on Sessions.
 - Debate

➤ **Demonstration Based Teaching**

For few courses the faculty adopted live demonstration like

- Unix & Shell Programming – Command and Script Execution
- CG & Cuda – Open GL & Cuda Program Demonstration
- IOT - Hardware Interfacing Demo
- CCP – Computer assembling Demo
- Android – Programming for APP development
- Python- Scripting demo
- Internet Network Security

➤ **App Based Teaching**

For the couple of the courses, student will use Mobile App during the delivery of course, which will enable them to understand the concepts effectively.

- CCP – Programming to understand C Language constructs

NITTE MEENAKSHI INSTITUTE OF TECHNOLOGY

(A Unit of Nitte Education Trust(R),Mangalore)

(AN AUTONOMOUS INSTITUTION AFFILIATED TO VISVESVARAYA TECHNOLOGICAL UNIVERSITY,BELGAUM)

APPROVED BY UGC,ACCREDITED BY NATIONAL BOARD OF ACCREDITATION (AICTE), NEW DELHI & NAAC

With A+ Grade

Govindapura, Gollahalli, P.B. No 6429, Yelahanka, Bangalore 560-064, Karnataka, India



```
1 #include<stdio.h>
2 main()
3 {
4     int a=5,b=2,k=7,x;
5     x=0==1&&k++;
6     printf("%d", x);
7 }
```

Buttons: OPEN, NEW, SAVE, COMPILE, RUN

- Unix- Command & Script Execution to understand the unix & shell concepts

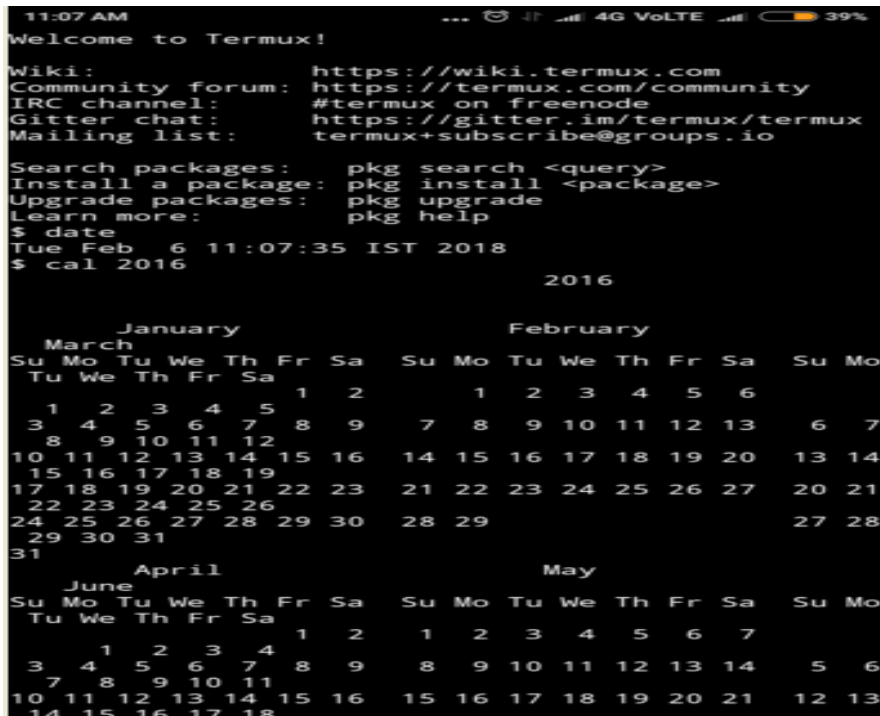

```
11:07 AM 4G VoLTE 39%
Welcome to Termux!
Wiki: https://wiki.termux.com
Community forum: https://termux.com/community
IRC channel: #termux on freenode
Gitter chat: https://gitter.im/termux/termux
Mailing list: termux+subscribe@groups.io

Search packages: pkg search <query>
Install a package: pkg install <package>
Upgrade packages: pkg upgrade
Learn more: pkg help
$ date
Tue Feb 6 11:07:35 IST 2018
$ cal 2016

                2016
    January                February
  Su Mo Tu We Th Fr Sa  Su Mo Tu We Th Fr Sa  Su Mo
  Tu We Th Fr Sa          Tu We Th Fr Sa          Tu We Th Fr Sa
    1  2  3  4  5          1  2  3  4  5  6          1  2  3  4  5  6
    6  7  8  9 10 11 12    7  8  9 10 11 12 13    7  8  9 10 11 12 13
   13 14 15 16 17 18 19   14 15 16 17 18 19 20   14 15 16 17 18 19 20
   20 21 22 23 24 25 26   21 22 23 24 25 26 27   21 22 23 24 25 26 27
   27 28 29 30 31          28 29                    27 28
   31                      30 31                    29 30 31
    April                    May
  Su Mo Tu We Th Fr Sa  Su Mo Tu We Th Fr Sa  Su Mo
  Tu We Th Fr Sa          Tu We Th Fr Sa          Tu We Th Fr Sa
    1  2  3  4          1  2  3  4  5  6  7          1  2  3  4  5  6  7
    8  9 10 11 12 13 14   8  9 10 11 12 13 14          8  9 10 11 12 13 14
   15 16 17 18 19 20 21   15 16 17 18 19 20 21          15 16 17 18 19 20 21
   22 23 24 25 26 27 28   22 23 24 25 26 27 28          22 23 24 25 26 27 28
   29 30 31                29 30 31                    29 30 31
```

NITTE MEENAKSHI INSTITUTE OF TECHNOLOGY

(A Unit of Nitte Education Trust(R),Mangalore)

(AN AUTONOMOUS INSTITUTION AFFILIATED TO VISVESVARAYA TECHNOLOGICAL UNIVERSITY,BELGAUM)

APPROVED BY UGC,ACCREDITED BY NATIONAL BOARD OF ACCREDITATION (AICTE), NEW DELHI & NAAC

With A+ Grade

Govindapura, Gollahalli, P.B. No 6429, Yelahanka, Bangalore 560-064, Karnataka, India

➤ Certification Based Learning

Certification based learning enable the student to attain Lifelong learning skills and improves their knowledge in the area of study. Certification from reputed organization will benefit for their career growth. For few of the courses, we have implemented Certification Based Learning.

- C Programming
- Object Oriented Programming with C++
- Data Structures using C
- Python for Data Science

At the end of the course, students will take online examination to obtain the certificates from

- IIT Bombay Spoken Tutorial
- Microsoft
- Course era
- Udemy
- Eckovation
- Edx

NITTE MEENAKSHI INSTITUTE OF TECHNOLOGY

(A Unit of Nitte Education Trust(R),Mangalore)

(AN AUTONOMOUS INSTITUTION AFFILIATED TO VISVESVARAYA TECHNOLOGICAL UNIVERSITY,BELGAUM)

APPROVED BY UGC,ACCREDITED BY NATIONAL BOARD OF ACCREDITATION (AICTE), NEW DELHI & NAAC

With A+ Grade

Govindapura, Gollahalli, P.B. No 6429, Yelahanka, Bangalore 560-064, Karnataka, India

VERIFIED
CERTIFICATE of ACHIEVEMENT



This is to certify that

Sweta

successfully completed and received a passing grade in

DAT208x: Introduction to Python for Data Science

a course of study offered by Microsoft, an online learning initiative of Microsoft Corporation through edX.

Satya Nadella
Chief Executive Officer
Microsoft Corporation

Björn Rettig
Senior Director of School of Applied Technology
Microsoft Corporation

Filip Schouwenaars
Content Developer
DataCamp

edX VERIFIED CERTIFICATE
Issued October 25, 2017

VALID CERTIFICATE ID
8600bbca2d8e49c898b9c66865155111

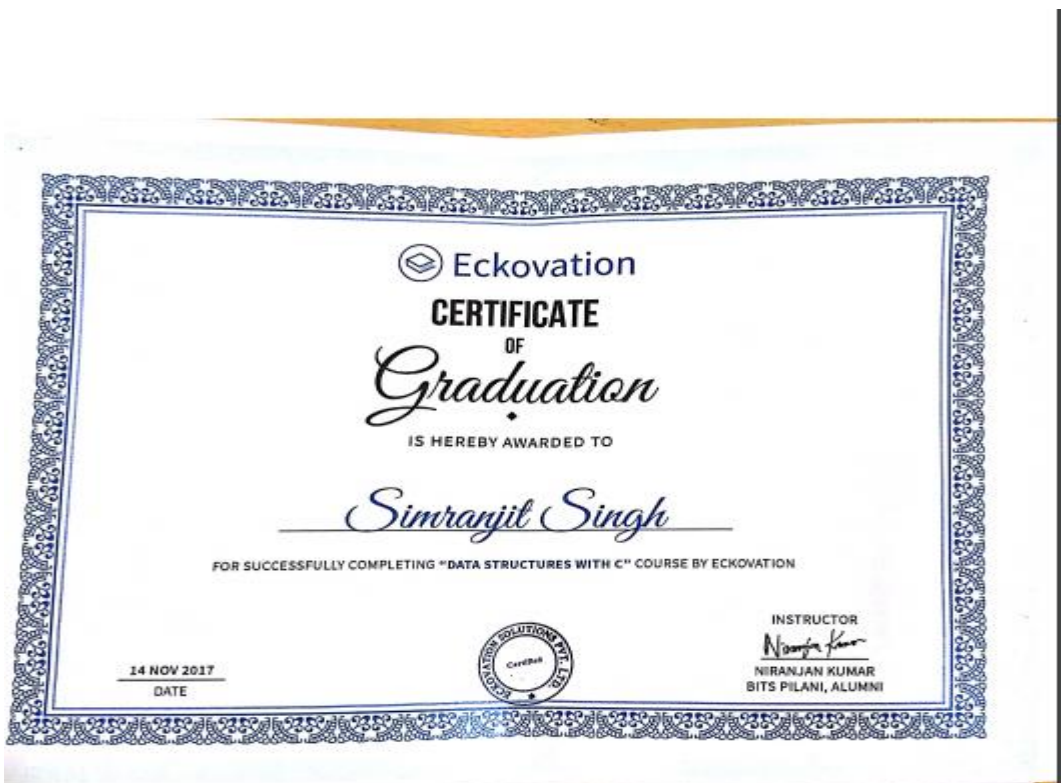

NITTE MEENAKSHI INSTITUTE OF TECHNOLOGY

(A Unit of Nitte Education Trust(R),Mangalore)

(AN AUTONOMOUS INSTITUTION AFFILIATED TO VISVESVARAYA TECHNOLOGICAL UNIVERSITY,BELGAUM)

APPROVED BY UGC,ACCREDITED BY NATIONAL BOARD OF ACCREDITATION (AICTE), NEW DELHI & NAAC

With A+ Grade

Govindapura, Gollahalli, P.B. No 6429, Yelahanka, Bangalore 560-064, Karnataka, India



➤ Conduction of Tutorial Classes

- Course Coordinator will prepare the Tutorial Sheet which will be reviewed by DUGC
- During the tutorial hour, student will solve the problems in group which will enhance their communication and ability to work in group
- Tutorial classes will be moderated by one or two faculty members
- In couple of courses, students interaction with the group is considered for evaluation
- In programming based courses, students are using laptops or apps to solve the given problem
- Example Tutorial Sheets

NITTE MEENAKSHI INSTITUTE OF TECHNOLOGY

(A Unit of Nitte Education Trust(R),Mangalore)

(AN AUTONOMOUS INSTITUTION AFFILIATED TO VISVESVARAYA TECHNOLOGICAL UNIVERSITY,BELGAUM)

APPROVED BY UGC,ACCREDITED BY NATIONAL BOARD OF ACCREDITATION (AICTE), NEW DELHI & NAAC

With A+ Grade

Govindapura, Gollahalli, P.B. No 6429, Yelahanka, Bangalore 560-064, Karnataka, India



Nitte Meenakshi Institute of Technology

(AN AUTONOMOUS INSTITUTION, AFFILIATED TO VISVESVARAYA TECHNOLOGICAL UNIVERSITY, BELGAUM) , (A Unit of Nitte Education Trust, Mangalore)

PE No. 5429, Yelahanka, Bangalore 560-064, Karnataka

Telephone: 080- 22157850, Fax: 080 - 22157805

Department of Information Science Engineering



COMPUTER CONCEPTS AND PROGRAMMING

Tutorial -3

1. Write a program to read two positive numbers, say n1 and n2 are interchange without using any extra variables n1=10, n2=20 then output is n1=20, n2=10 by the multiplication (*) and division (/)

2. Write a C program to read decimal value and convert to Octal, Hexadecimal using printf in C

3. Write a C program to print ASCII value of entered character.



4. Write a C program to calculate EMI when, loan amount (principal), rate and time in years are given and then prints the per month EMI of that loan amount.

Formula is $P * R * (1 + R)^T / ((1 + R)^T - 1)$

- P is loan amount.
- R is interest rate per month - we will read in yearly and convert in monthly in program.
- T is loan time period in year - we will read in yearly and convert in monthly in program.

5. Write a C program Calculate Employee and Employer Provident Fund

±

 NITTE MEENAKSHI INSTITUTE OF TECHNOLOGY (An Autonomous Institution Under Visvesvaraya Technological University, Belgaum) YELAHANKA, BANGALORE Department of Information Science and Engineering		
Tutorial Sheet		
Semester: 3, A,B,C-sections; Subject: DMS; Sub.code:14IS34		
Q.No		
1	Construct a truth table for each of the following compound propositions: a) $\neg p \rightarrow (q \rightarrow r)$ b) $(p \rightarrow q) \wedge (\neg p \rightarrow q)$ c) $(p \vee q) \rightarrow (p \wedge q)$	
2	Determine whether each of the following are tautology, contradiction or contingency a) $(p \wedge (p \rightarrow q)) \rightarrow q$ b) $(q \wedge \neg p) \leftrightarrow r$ c) $(p \vee q) \vee (p \leftrightarrow q)$	
3	Show that $p \leftrightarrow q$ and $(p \wedge q) \vee (\neg p \wedge \neg q)$ are equivalent	
4	Show that $(p \wedge q) \rightarrow r$ and $(p \rightarrow r) \wedge (q \rightarrow r)$ are not logically equivalent	
5	Simplify the following logical statements using laws of logic a) $(p \vee q) \wedge \neg (\neg p \vee q)$ b) $\neg (\neg ((p \vee q) \wedge r) \vee \neg q)$	
6	Find the negation on the statement "If x is not a real number, then it is not a rational number and not an irrational number"	

NITTE MEENAKSHI INSTITUTE OF TECHNOLOGY

(A Unit of Nitte Education Trust(R),Mangalore)

(AN AUTONOMOUS INSTITUTION AFFILIATED TO VISVESVARAYA TECHNOLOGICAL UNIVERSITY,BELGAUM)

APPROVED BY UGC,ACCREDITED BY NATIONAL BOARD OF ACCREDITATION (AICTE), NEW DELHI & NAAC

With A+ Grade

Govindapura, Gollahalli, P.B. No 6429, Yelahanka, Bangalore 560-064, Karnataka, India

➤ Course Project:

- Problem statements related to modules of real world applications are defined by course coordinator
- It is mandatory to follow Software Development Life Cycle.
- Effective Rubric has been designed to evaluate the course project
- Example Rubrics and project groups are shown below:

OOPs Project Groups							
File Edit View Insert Format Data Tools Add-ons Help							
75% £ % .00 .00 123 Arial 10 B I S A							
GROUP NUMBER							
A	B	C	D	E	F	G	H
1	GROUP NUMBER	NAMES	Note : MAX 4 in a group			Contact Person	
2	1	ASIF H	NMIT Employee Payroll Management System			Ms Sony Malli & Team	
3		G. RAHUL					
4		SHYAMANTH KASHYAP					
5		PRAJWAL . JM					
6							
7	2	Abhishek Kumar	NMIT Library Management			Mr. Gangahar & Team	
8		Arkit Raj					
9		Arkit Verma					
10		Santosh Tharu					
11							
12	3	Kavya.KN	NMIT Girls hostel Management System			Ms. Sneha or Dr. Sriatha	
13		Krithika.B					
14		Meghashree.KM					
15		Padmini					
16							
17	4	Arya Dev	NMIT Employee Leave Management System			Ms Sony Malli & Team	
18		Prajwal M					
19		P. Vihnu					
20		Milind Kulgod					
21							
22	5	Deepika K	NMIT Canteen Stock Management			Canteen Head	
23		Nithya N Shanbhag					
24		Bhavani A C					
25							
26	6	Anirudh BS	NMIT Bus Management System			Transport Dept	
27		Samuel Ros han Kumar					

Rubrics for Course Project (OOP):

Nitte Meenakshi Institute of Technology

Department of Information Science and Engg.

Rubrics of Course Project Evaluation for course "Principles of Parallel Programming"

Performance Indicator	Satisfactory	Good	Excellent
Understanding of concept	Not put effort to understand	Has put effort but not understood	Has understood concept clearly
Present and communicate effectively	Not able to prepare presentation in a organized manner & present effectively	Prepared presentation well but not able to present effectively.	Presentation was very effective
Design	Not able to show the design of their problem statement effectively	Has idea about the design but not able to put it effectively in presentation	Is able to show the design of their presentation effectively
Role as a group member	Only interested in his/her part of work and not able to coordinate the group	Has idea about every part of project but in presentation only worried about self-presentation and most of the time trying to talk about everything blocking his partner	Understand and co-ordinate each phase of project also during presentation allows each member to present effectively
Interpretation of result	Not able to run project for various cases	Only few cases are considered	Has considered all the cases in project

NITTE MEENAKSHI INSTITUTE OF TECHNOLOGY

(A Unit of Nitte Education Trust(R),Mangalore)

(AN AUTONOMOUS INSTITUTION AFFILIATED TO VISVESVARAYA TECHNOLOGICAL UNIVERSITY,BELGAUM)

APPROVED BY UGC,ACCREDITED BY NATIONAL BOARD OF ACCREDITATION (AICTE), NEW DELHI & NAAC

With A+ Grade

Govindapura, Gollahalli, P.B. No 6429, Yelahanka, Bangalore 560-064, Karnataka, India

➤ Case study:

- Case study allowed the students to analyse the latest innovations in the field and also as students work in group and present their study, their communication and group working skills will be enhanced.
- Also, in courses like parallel computing students analyse tools like profiling tools
- Some of the Courses
 - Parallel Computing - Case Study on Current Technology
 - Graph Theory -Case Study on Real world application of Graph Theory Concepts
 - Computer Organization - Case study on Latest Innovations in the field of Computer Science
 - Computer Network - Case Study on current technology
 - Adhoc Networks - Case Study on Current Technology (Transaction, IEEE, Springer, ACM.. etc. referred Journals)
 - Software Project Management
 - FOSS & Cyber Laws
 - VPN – Case study -on various entrepreneurs and their journey to success
 - Storage Area Networks- On current trends
 - Internet Network Security

COMPUTER NETWORKS II (2016-17)				
CASE STUDY				
Performance Indicator	Satisfactory	Good	Excellent	
Areas covered	Not put effort to understand	Has put effort but not understood	Has understood concept clearly	
Present and communicate effectively	Not able to prepare presentation in a organized manner & present effectively	Prepared presentation well but not able to present effectively.	Presentation was very effective	
Design	Not able to show the design of their problem statement effectively	Has idea about the design but not able to put it effectively in presentation	Is able to show the design of their presentation effectively	
Role as a group member	Only interested in his/her part of work and not able to coordinate the group	Has idea about every part of project but in presentation only worried about self-presentation and most of the time trying to talk about everything blocking his partner	Understand and co-ordinate each phase of project also during presentation allows each member to present effectively	
Professional Skills	Has not submitted the	Few assignments are	All the assignments	

NITTE MEENAKSHI INSTITUTE OF TECHNOLOGY

(A Unit of Nitte Education Trust(R),Mangalore)

(AN AUTONOMOUS INSTITUTION AFFILIATED TO VISVESVARAYA TECHNOLOGICAL UNIVERSITY,BELGAUM)

APPROVED BY UGC,ACCREDITED BY NATIONAL BOARD OF ACCREDITATION (AICTE), NEW DELHI & NAAC

With A+ Grade

Govindapura, Gollahalli, P.B. No 6429, Yelahanka, Bangalore 560-064, Karnataka, India

	assignment / all the assignments are submitted after deadline	submitted after deadline	are submitted within deadline.	
Creative Skills	Not shown any creativity in case study	Little effort in creativity.	Has shown tremendous creativity in presenting the case study	

➤ Course Debate/Group Discussion:

- 2 teams consisting of 6 in each team will debate on topic related to course
 - Course coordinator will identify the set of topics
 - eg:1.FDI is boon or bane with respect to VPM
- Eg: 2: debate on open source with respect to FOSS



➤ Programming Assignments

- For some of the programming based courses , course instructors will define set of programming assignments
 - ADA
 - FLAT- JFLAP Based Assignment
 - Computer Network- NS3 based Assignment
 - Client Server Programming
 - Operating Systems
- This exercise will ensures well understanding of programming language constructs

NITTE MEENAKSHI INSTITUTE OF TECHNOLOGY

(A Unit of Nitte Education Trust(R),Mangalore)

(AN AUTONOMOUS INSTITUTION AFFILIATED TO VISVESVARAYA TECHNOLOGICAL UNIVERSITY,BELGAUM)

APPROVED BY UGC,ACCREDITED BY NATIONAL BOARD OF ACCREDITATION (AICTE), NEW DELHI & NAAC

With A+ Grade

Govindapura, Gollahalli, P.B. No 6429, Yelahanka, Bangalore 560-064, Karnataka, India

Nitte Meenakshi Institute of Technology

Department of Information Science and Engineering

Subject name: Analysis and design of algorithms

Subject code: 14IS43

Semester: IV

PROGRAMMING ASSIGNMENTS

- When the city planners developed your neighbourhood they numbered the 'n' houses in a random order. Write a C program to search for a house using linear search. Also find the time complexity and space complexity.
 - Consider a list of employee's salaries arranged in ascending order. Write a C program to search for a salary using recursive and non-recursive versions of binary search. Also find its time and space complexity.
- Consider a list of 'n' files numbered using ID's. Write a C program to search for a file based on its ID using merge sort. Also find its time and space complexity.
- Design a quicksort program in 'C' to arrange a given array of 'n' real numbers so that all its negative elements precede all its positive elements. Find its time and space complexity.
- Write a C program that, for a given digraph outputs all the vertices reachable from a given starting vertex using BFS method. Find its time and space complexity.
- Consider a network having 'n' systems. Design a DFS based program in 'C' which outputs all systems reachable from a given system. Find its time and space complexity.
- Suppose you are given a list of students who are assigned IDs. Write a C program to sort these students based on their id's using heapsort. Find its time and space complexity.

NITTE MEENAKSHI INSTITUTE OF TECHNOLOGY

(A Unit of Nitte Education Trust(R),Mangalore)

(AN AUTONOMOUS INSTITUTION AFFILIATED TO VISVESVARAYA TECHNOLOGICAL UNIVERSITY,BELGAUM)

APPROVED BY UGC,ACCREDITED BY NATIONAL BOARD OF ACCREDITATION (AICTE), NEW DELHI & NAAC

With A+ Grade

Govindapura, Gollahalli, P.B. No 6429, Yelahanka, Bangalore 560-064, Karnataka, India

1. Draw a DFA to accept the language $L = \{w : w \text{ has odd number of } 1\text{'s followed by even number of } 0\text{'s}\}$

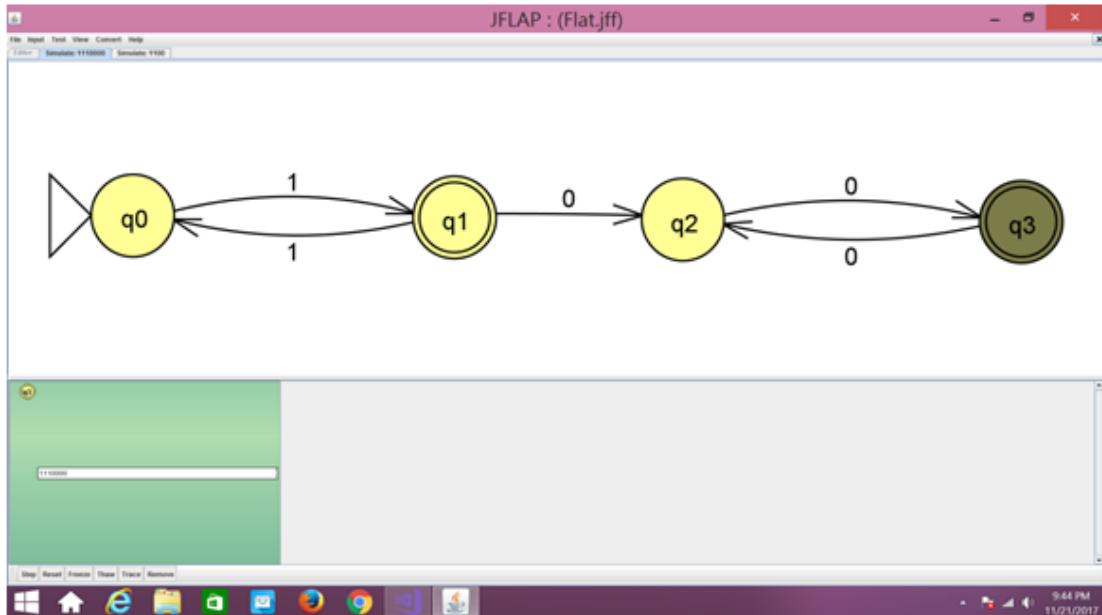

4. LABORATORY COURSES:

- Laboratory experiments based on real world and domain specific problem statements
- Rubric evaluation has been introduced in individual lab classes to assess the overall improvements
- Discussion about the problem statement and possible design will be continued by the students implementing and testing the code

5. INTERNSHIP:

- It is mandatory for Fast Learners to pursue Industry Internship for the period of 2 months
- Department will assist the students to get Industry Internship
 - Paid Internship from TGE Global-USA
 - Paid Internship from JNCASR
 - Paid Internship from Kore Fabrics
 - Internship from IISc, IIT & NITs, etc.
- Dept. also allow the final year student to take-up long term Internship
- Well defined Rubrics for evaluation of Internship

6. MAIN PROJECT:

NITTE MEENAKSHI INSTITUTE OF TECHNOLOGY

(A Unit of Nitte Education Trust(R),Mangalore)

(AN AUTONOMOUS INSTITUTION AFFILIATED TO VISVESVARAYA TECHNOLOGICAL UNIVERSITY,BELGAUM)

APPROVED BY UGC,ACCREDITED BY NATIONAL BOARD OF ACCREDITATION (AICTE), NEW DELHI & NAAC

With A+ Grade

Govindapura, Gollahalli, P.B. No 6429, Yelahanka, Bangalore 560-064, Karnataka, India

- Department prefers In-house project, the problem will be defined by the Student in consultation with Project Supervisor.
- During project Phase–I review, the problem statement will approved by the panel.
- Review Panel will make sure that the student to undergo Project Development life cycle by well-defined performance indicators
- During technical seminar, student has to present the Literature related to their project
- Review meeting are organized twice in a semester
- Mandatory to meet Supervisor at least twice a week
- Department has initiated Mandatory Plagiarism check for the project report. Plagiarism report will be enclosed in Project report
- For every project, it is mandatory to prepare draft paper for publication
- Effective Rubrics is designed for evaluation of Project

➤ Rubrics for project

25/04/2016

Nitte Meenakshi Institute of Technology
Department of Information Science and Engineering
Rubrics for Project

Subject and Code : Project Work (14ISP84) Max Marks : 50
Semester : VIII

Performance Indicator	Excellent (100%)	Good (80%)	Fair (50%)	Poor (20%)
Complete set of requirements are collected (5)	Satisfactory requirement analysis done with comparative study of available components / techniques and efficient selection.	Satisfactory requirement analysis done with comparative study of available components / techniques.	Satisfactory requirement analysis done.	No requirement analysis done.
Analysis & Designs (10)	Satisfactory design analysis performed and all design aspects are justified.	Satisfactory design analysis performed but only few design aspects are justified.	Satisfactory design analysis performed.	No design analysis performed.
Literature Review (5)	Referred papers are related and new and justification for its selection is provided.	Referred papers are related and new, but no justification for its selection is provided.	Referred papers are old and not related to the topic.	No literature Survey done.
Implementation (20)	All modules implemented based on proposed design and are optimized.	All modules implemented based on proposed design but are not optimized.	Some modules implemented based on proposed design.	No implementation done based on proposed design.
Present and communicate effectively (5)	Language and/or delivery resulted information being communicated orally with high degree of effectiveness.	Language and/or delivery resulted information being communicated orally with considerable effectiveness.	Language and/or delivery resulted information being communicated orally with some effectiveness.	Language and/or delivery resulted information being communicated orally with limited effectiveness.
Relevance with Real World Application (5)	The project has sufficient real world application and has been well addressed.	The project has potential to be related to some world application and has been well addressed.	The project has potential to be related to some real world application but not well addressed.	The project does not relate to any real time or real world application.

➤ Plagiarisms check report:

NITTE MEENAKSHI INSTITUTE OF TECHNOLOGY

(A Unit of Nitte Education Trust(R),Mangalore)

(AN AUTONOMOUS INSTITUTION AFFILIATED TO VISVESVARAYA TECHNOLOGICAL UNIVERSITY,BELGAUM)

APPROVED BY UGC,ACCREDITED BY NATIONAL BOARD OF ACCREDITATION (AICTE), NEW DELHI & NAAC

With A+ Grade

Govindapura, Gollahalli, P.B. No 6429, Yelahanka, Bangalore 560-064, Karnataka, India

GANESH HEGDE 1			
ORIGINALITY REPORT			
%5	%4	%4	%1
SIMILARITY INDEX	INTERNET SOURCES	PUBLICATIONS	STUDENT PAPERS
PRIMARY SOURCES			
1	ijarcce.com Internet Source		%1
2	Almasri, Marwah M., Khaled M. Elleithy, and Abrar M. Alajlan. "Development of efficient obstacle avoidance and line following mobile robot with the integration of fuzzy logic system in static and dynamic environments", 2016 IEEE Long Island Systems Applications and Technology Conference (LISAT), 2016. Publication		%1
3	Saxena, Ankita, and Abhinav Saxena. "A new generation grid solver Robot system for object picking using shortest path", 2012 International Conference on Emerging Trends in Electrical Engineering and Energy Management (ICETEEEM), 2012. Publication		%1
4	lbrce.ac.in Internet Source		%1
5	www.deepdyve.com Internet Source		%1
	docslide.us		

➤ Draft paper:

Smart Service System for Restaurant

Ganesh Hegde¹, Nagraj M Srivatsa², Mohammed Arshad³, Ranjan MB¹, Mrs Ashwini JP⁴
¹BE Student, Dept. of Information Science & Engg.
²Asss. Professor, Dept. of Information Science & Engg.
Nitte Meenakshi Institute of Technology, Yelahanka, Bangalore – 560 064

Abstract—

With restaurants developing in every hook and corner of the city hotel industry is blooming. Man power deficiency is the main problem faced by this industry. Less manpower may lead to unhappy clients and in turn may be the reason of loss. The work proposed here provides a robot based solution for this problem. A one stop solution considering different dimensions like collecting the order from client, conveying it to the chefs and finally servicing it through robots is proposed in this work. A cloud based solution consisting of an app to collect the menu and a line follower robot for serving the order with a collision avoidance mechanism is implemented and tested here. The results show that the solution can be implementable in cost effective manner even for small scale restaurants.

Keywords: Line following robot, IR Sensors, Ultrasonic sensor, Collision, Detection, client server model, UDP.

I. INTRODUCTION

With restaurants opening in every corner of the city and number of people opting for outside food is increasing due to which hotel industry is facing manpower problem. To provide a technical help in this regard we are proposing "Smart Service System for Restaurant" which emphasis on simple line follower robotic system which follows path/line to serve the ordered food to particular customer by following the line.

Traditional method that is used commonly in hotels is by taking the customer's orders and writing it down on a piece of paper and then giving the order in the kitchen section. The food ordering system is proposed with the use of a handheld device placed on each table which is used to make an order at the restaurant. Waiters making mistakes with customers orders. Customers have to wait for a waiter to take their order, impatient customers. Waiters need to constantly check with the chefs to determine when food is ready. Smart service systems for restaurants are a service provided to customers as well as workers of the restaurant. This system is a concept where a restaurant working is based on using the state of the art technology from ordering to delivery. This system presents a restaurant management in efficient way and to reduce man power.

II. PROPOSED WORK

The work considers three modules.

1. An app for displaying the menu and collecting the orders from customers.
2. An app to convey the orders to chefs.
3. A robot food serving method

In the first module customers will be provided with a tab which displays the menu and provides an option for the customers to choose their order. Data will be stored on the cloud platform and forwarded for the chefs.

Second module will provide an interface for the chefs to see the current orders. When the food is ready they will place it on the serving robots and submit the details.

In the third module, line following robots are used for serving the food. But major concern here is the scenario where two robots may be moving on the same line in opposite direction. A collision detection mechanism using ultrasonic sensors is implemented in this work where robots avoid collision through a small deflection in the chosen path.

III. LITERATURE SURVEY

In design and implementation of line follower robot 2009 IEEE paper[1], The Line follower robot is a machine that takes the light reflected back from the surface and moves accordingly. By and large, the way is already fixed and can be either the white line on the black surface or the black line on the white floor or it can be undetectable like an attractive field. Their work mainly concentrated on microcontrollers.

In development of efficient obstacle avoidance and line following mobile robot of 2014 IEEE paper[2], the robot moves according to the line drawn on the floor and it has one input and two outputs. The main intension is to make the robot travel without colliding with any obstacle.

In obstacle avoidance robot of 2016 IJSETR paper[3], ultrasonic sensors which consists of emitter and detector were used for obstacle detection which can measure the distance of about 100 to 100 points.